

VC-1090 FLEXHORN 45 OHM TALKBACK HORN WITH VOLUME CONTROL

INTRODUCTION

The Valcom VC-1090 Flexhorn is a 45 Ohm talkback horn designed to be used with Valcom "handsfree" talkback control units. The volume control is on the face of the horn. This horn is weatherproof and can be used indoors or outside in environments ranging from -20 to +55° C.

Model VC-1090-GY	Gray
Model VC-1090-BGE	Beige
Model VC-1090-W	White



CONNECTIONS

White	-	Tip/A
Black	-	Ring/B

DIMENSIONS/WEIGHT

- 6.8"H x 8.3"W x 3.3"D
(17.3cm H x 21.1cm W x 8.4cm D)
- 2 lbs. (0.91 kg)

MOUNTING

FLUSH MOUNT

Using the template packaged with the speaker, draw the speaker outline on the wall to be cut. Make appropriate wiring connections and test the speaker for operation. Using appropriate mounting screws (not furnished) drill and mount the flange as shown.

UNIVERSAL BRACKET

Loosen or separate the universal bracket leaves by loosening or removing the handle and hardware. Using the back leaf as a template, mark the wall through the mounting holes. Drill and mount to the wall using appropriate screws (not furnished) or mount directly to a junction box. Mount the T-bracket to the back of the horn as shown using the (2) ½" screws provided.

"C" CLAMP FOR "I" BEAM MOUNTING

A "C" clamp is provided with the horns to allow mounting to a beam. Place the bolt through the hole in the bottom of the base to secure the "C" clamp to the beam. It is suggested that the horn be mounted to the underside of the "I" beam to provide the maximum of positioning adjustments. Mount the "C" clamp with (2) 1/2" screws provided.

TECHNICAL ASSISTANCE

When trouble is reported, verify there are no broken connections. Assistance in troubleshooting is available from the factory. Call (877) 427-2166 and ask for Class Connection Technical Support.

Valcom equipment is not field repairable. Valcom, Inc. maintains service facilities in Roanoke, VA. Should repairs be necessary, attach a tag to the unit clearly stating company name, address, phone number, contact person, and nature of the problem. Send the unit to:

Valcom, Inc.
Repair and Return Dept.
5614 Hollins Road
Roanoke, VA 24019-5056

TROUBLESHOOTING CHART	
PROBLEM	PROBABLE CAUSE AND CORRECTION
No sound in page mode.	- Check tip and ring for audio at speaker. - Check tip and ring for audio at control unit.
Low sound in page mode.	- Check volume controls at page control.
Poor listening in talkback mode.	- Check talkback volume control at page control. Set control where audio is clearly audible.

CLASS CONNECTION LIMITED WARRANTY

Class Connection warrants its products only to the original purchaser, for its own use, to be free from defects in materials and workmanship under conditions of normal use and service for a period of two years from the date of shipment. This Limited Warranty obligation shall be limited to the replacement, repair or refund of any such defective device within the warranty period, provided that:

1. inspection by Class Connection indicates the validity of the claim;
2. the defect is not the result of damage, misuse or negligence after the original shipment;
3. the product has not been altered in any way or repaired by others and that factory sealed units are unopened (a service charge plus parts and labor will be applied to units defaced or physically damaged);
4. freight charges for the return of products to Class Connection are prepaid;
5. all units 'out of warranty' are subject to a service charge. The service charge will cover minor repairs (major repairs will be subject to additional charges for parts and labor).

This Limited Warranty is in lieu of and excludes all other warranties, expressed or implied and in no event shall Class Connection be liable for any anticipated profits, consequential damages, loss of time or other losses incurred by the buyer in connection with the purchase, operation, maintenance, installation, removal or use of the product. The maximum liability of Class Connection under this warranty is limited to the purchase price of the specific Product covered by the warranty.

Disclaimer. Except for the Limited Warranty provided herein, the product is provided "as-is" without any warranty of any kind whatsoever including, without limitation, any **WARRANTY OF MERCHANTABILITY, FITNESS FOR A PARTICULAR PURPOSE OR NON-INFRINGEMENT.**

This warranty specifically excludes damage incurred in shipment. In the event a product is received in damaged condition, the carrier should be notified immediately. Claims for such damage should be filed with the carrier involved in accordance with the F.O.B. point.

Headquarters:
Class Connection
5614 Hollins Road Roanoke, VA 24019-5056
Phone: (877) 427-2166 FAX: (540) 362-9800

UNIVERSAL BRACKET

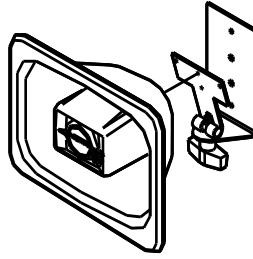

OR SURFACE MOUNTED WITH
A UNIVERSAL MOUNTING BRACKET

"C" CLAMP FOR "I" BEAM MOUNTING

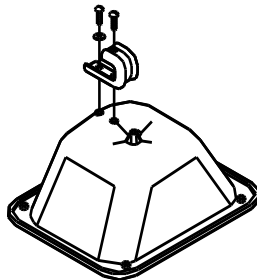

ATTACH CLAMP TO HORN

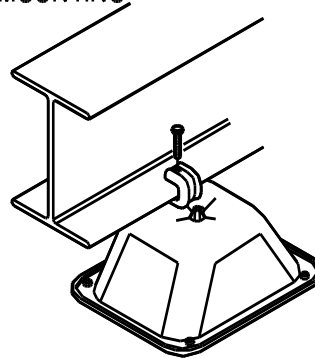

ATTACH FLEXHORN TO BEAM

USING MOUNTING SCREWS:

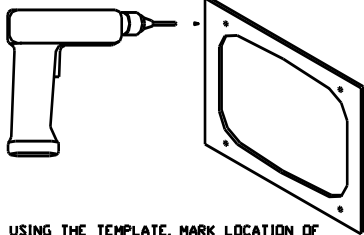

USING THE TEMPLATE, MARK LOCATION OF
OPENING AND MOUNTING HOLES ON WALL.
DRILL HOLES APPROPRIATE TO YOUR MOUNTING
HARDWARE AND CUT OUT THE OPENING.

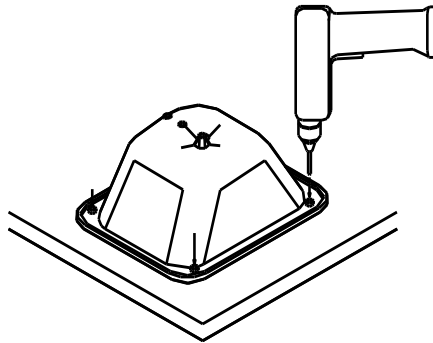

HOLDING FLEXHORN FIRMLY AGAINST A FLAT
SURFACE, DRILL THROUGH EACH MOUNTING BOSS AS SHOWN

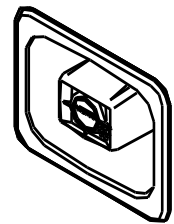

FLUSH MOUNTED IN A STUD WALL,
INSTALLED WITH MOUNTING SCREWS OR
CONSTRUCTION CEMENT

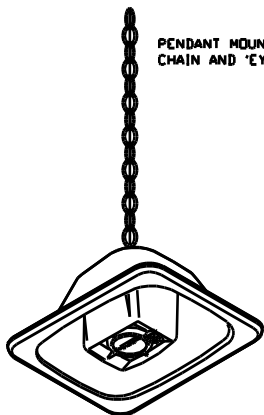

PENDANT MOUNTING WITH OPTIONAL
CHAIN AND 'EYE' SCREW

OTHER MOUNTING OPTIONS:

OPTIONAL V-9805
VANDAL RESISTANT ENCLOSURE

